

## Spectrum Estimation of Non-Stationary Signals in Power Systems

Z. Leonowicz<sup>2</sup>, T. Lobos<sup>1</sup>, and J. Rezmer<sup>1</sup>,

(1) Dept. of Electrical Engineering, Wroclaw University of Technology, pl. Grunwaldzki 13, Wroclaw, 50-370, Poland (e-mail: lobos@ipee.pwr.wroc.pl, rezmer@ipee.pwr.wroc.pl), (2) BSI RIKEN ABSP Lab., 2-1, Hirosawa, Wako-shi, Saitama, 351-0198 Japan, (e-mail: leon@bsp.brain.riken.go.jp), on leave from Dept. of Electrical Engineering, Wroclaw University of Technology, Poland.

**Abstract** – Time-varying spectra of non-stationary time-series commonly used are spectrograms from the Short-Time Fourier Transform (STFT). The most prominent limitation of the Fourier Transform is that of frequency resolution. To overcome the limitation the Wavelet Transform, Wigner-Ville Distribution and the Min-Norm subspace method have been applied for spectrum estimation of non-stationary signals caused by switching on capacitor banks and by a short circuit at the output of a frequency converter. Investigation results confirm the advantages of the advanced methods.

**Keywords** – fault diagnosis, power systems, pulse width modulated power converters, subspace methods, time-frequency analysis, wavelet transforms, Wigner distributions.

### I. INTRODUCTION

The aim of signal analysis is to extract relevant information from a signal by transforming it. Spectrum estimation of discretely sampled deterministic and stochastic processes is usually based on procedures employing the Fast Fourier Transform (FFT). Conventional FFT spectral estimation is based on a Fourier series model of the data, that is the process is assumed to be composed of a set of harmonically related sinusoids. This approach to spectrum analysis is computationally efficient and produces reasonable results for a large class of signal processes. In spite of these advantages there are several inherent performance limitations of the FFT approach. The most prominent limitation is that of frequency resolution, i.e. the ability to distinguish the spectral responses of two or more signals. Because of some invalid assumptions (zero data or repetitive data outside the duration of observation) made in this methods, the estimated spectrum can be a smeared version of the true spectrum. A second limitation is due to windowing of the data, that occurs when processing with the FFT. Windowing manifests itself as leakage in the spectral domain – energy in the main lobe of a spectral response leaks into the side-lobes, obscuring and distorting other spectral responses that are present. These two performance limitations of the FFT approach are particularly troublesome when analysing short data records. Short data records occur frequently in practice, because many measured processes are brief in duration or have slowly time-varying spectra, that can be considered constant only for short record lengths. In an attempt to alleviate the limitations of the FFT approach, many alternative spectral estimation procedures have been proposed within the last 4-5 decades.

In the case of a non-stationary signal, any change of the signal causes a continuous spectrum which spread out over the whole frequency axis. Therefore other methods of analysis are needed, to get a two-dimensional time-frequency representation  $S(t, \omega)$  of the investigated signal. First, Gabor has adapted the Fourier Transform to define the  $S(t, \omega)$ , assuming that the signal is stationary when seen through a window of limited extent. This yields the Short-Time Fourier Transform (STFT). The time varying spectra of non-stationary time series commonly used are spectrograms, from the STFT. If a signal is composed of small bursts of components, then each type of component can be analysed with good time resolution or frequency resolution, but not both. To overcome the resolution limitation, the Wavelet Transform (WT) has been developed. [7]. Wavelet Transform provides a unified framework for a number of methods, which have been developed independently for various signal processing applications. In contrast to the STFT, the WT uses short windows at high frequencies and long windows for low frequencies. Using the WT, the time-varying spectra of non-stationary signals can also be obtained in form of scalograms. Scalogram is defined as the squared modulus of the WT. In contrast to the spectrogram the energy of the signal is here distributed with different resolutions.

The WT is also related to the time-frequency analysis based on the Wigner-Ville Distribution (WVD). The Wigner-Ville spectrum shows better frequency concentration and less phase dependence than Fourier spectra [1, 3]

The subspace frequency estimation methods rely on the property that the noise subspace eigenvectors of a Toeplitz autocorrelation matrix are orthogonal to the eigenvectors spanning the signal space [2]. The model of the signal in this case is a sum of random sinusoids in the background of noise of a known covariance function. The eigenvectors spanning the noise space are the ones whose eigenvalues are the smallest and equal to the noise power. One of the most important techniques, based on the concepts of subspaces is the Min-Norm method [4].

Transients resulting from the switching capacitor banks in electrical distribution systems affects power quality. The estimation of parameters of transient components is very important for design of protection and control instruments. The transient waveforms have been investigated using Wavelet Transform (scalograms) and Wigner-Ville Distribution.

Reliability of power electronic drive systems is impor-

tant in many industrial applications. The analysis of fault mode behaviour can be utilised for development of monitoring and diagnostic systems. In this paper we present also some results of simulation investigations of a converter-fed induction motor drive. PWM converters supplying asynchronous motor were simulated. Detection of irregular frequencies may be useful for diagnosis of some drive faults.

Spectrum of the signal was estimated with the help of the Wavelet Transform (WT), Wigner-Ville Distribution (WVD) and Min-Norm method (subspace method).

## II. WIGNER-VILLE REPRESENTATION

The Wigner-Ville distribution is expressed by:

$$W_x(t, \omega) = \int_{-\infty}^{\infty} x\left(t + \frac{\tau}{2}\right) x^*\left(t - \frac{\tau}{2}\right) e^{-j\omega\tau} d\tau \quad (1)$$

where  $t$  is a time variable,  $\omega$  is a frequency variable and \* denotes complex conjugate.

For a discrete-time signal  $x(n)$  the discrete pseudo-Wigner-Ville distribution (PWD) is evaluated using a sliding symmetrical finite-length analysis window  $h(\tau)$  [6].

$$W_{xh}(n, k) = 2 \sum_{\tau=-L}^L x(n+\tau) x^*(n-\tau) \times h(\tau) h^*(-\tau) e^{-j4\pi k\tau/N} \quad (2)$$

where  $h(\tau)$  is a windowing function that satisfies the condition:  $h(\tau) = 0; |\tau| > L$ . Variables  $n$  and  $k$  correspond respectively to the discrete time and frequency variables. The Wigner-Ville distribution of a signal can attain negative values. Each time-frequency representation, which preserves marginal conditions cannot be positive everywhere. These local negative values does not have any physical meaning.

One main deficiency of the WVD is the cross-term interference. WVD of the sum of signal components is a linear combination of auto- and cross-terms. Each pair of the signal components creates one additional cross-term in the spectrum, thus the desired time-frequency representation may be confusing.

Traditionally, the cross-terms are considered as something undesired in the WVD [6] and should be removed. One way of lowering cross-term interference is to apply a low-pass filter to the WVD. The smoothing, however, will reduce the frequency resolution of the WVD and cause the loss of some useful properties of the transformation [5].

## III. WAVELET TRANSFORM

The continuous wavelet transform (CWT) of a signal  $f(t)$  depends on two variables: scale (or frequency) parameter  $a$ , and time parameter  $\tau$ . It is given by:

$$CWT(a, \tau) = \frac{1}{\sqrt{a}} \int_{-\infty}^{\infty} f(t) \underline{g}\left(\frac{t-\tau}{a}\right) dt \quad (3)$$

where  $\underline{g}(t)$  is the basic (or mother) wavelet, and

$$\frac{1}{\sqrt{a}} \underline{g}\left(\frac{t-\tau}{a}\right)$$

are the wavelet basis functions.

The basic wavelet can be real or complex.

The complex Morlet wavelet is defined by:

$$\underline{g}(t) = \sqrt{\pi \cdot f_B} \cdot e^{j2\pi f_C t} \cdot e^{-\frac{t^2}{f_B}} \quad (4)$$

where:

$f_B$  is a positive bandwidth parameter,

$f_C$  is a wavelet center frequency.

If the sampling period is  $T_P$ , it is natural to associate to the scale  $a$  the frequency:

$$f = \frac{T_P f_C}{a} \quad (5)$$

where:

$a$  is a scale.

$T_P$  is the sampling period.

$f_C$  is the center frequency of a wavelet in Hz.

$f$  is the frequency corresponding to the scale  $a$ , in Hz

## IV. MODIFIED MIN-NORM METHOD

The Min-Norm method involves calculation of the correlation matrix of the signal. Smallest eigenvalues of the matrix correspond to the noise subspace and largest (all greater than the noise variance) correspond to the signal subspace. The matrix of eigenvectors is defined by:

$$\mathbf{E}_{noise} = [\mathbf{e}_{M+1} \quad \mathbf{e}_{M+2} \quad \dots \quad \mathbf{e}_N] \quad (6)$$

$N-M$  smallest eigenvalues of the correlation matrix (matrix dimension  $N > M+1$ ) correspond to the noise subspace and  $M$  largest (all greater than  $\sigma_0^2$ ) corresponds to the signal subspace.

Min-norm method uses one vector  $\mathbf{d}$  for frequency estimation. This vector, belonging to the noise subspace, has minimum Euclidean norm and his first element equal to one. We can present  $\mathbf{E}_{noise}$  in the form:

$$\mathbf{E}_{noise} = \begin{bmatrix} \mathbf{c}^{*T} \\ \mathbf{E}'_{noise} \end{bmatrix} \quad (7)$$

where  $\mathbf{c}^{*T}$  is the upper row of the matrix. Hence  $\mathbf{c} = \mathbf{E}'_{noise}{}^{*T} \boldsymbol{\ell}$ , where  $\mathbf{d}^{*T} \boldsymbol{\ell} = 1$ . These conditions are expressed by the following equation:

$$\mathbf{d} = \frac{1}{\mathbf{c}^{*T} \mathbf{c}} \mathbf{E}_{noise} \mathbf{c} = \begin{bmatrix} 1 \\ (\mathbf{E}'_{noise} \mathbf{c}) / (\mathbf{c}^{*T} \mathbf{c}) \end{bmatrix} \quad (8)$$

Pseudospectrum defined with the help of  $\mathbf{d}$  is defined as:

$$\hat{P}(e^{j\omega}) = \frac{1}{|\mathbf{w}^{*T} \mathbf{d}|^2} = \frac{1}{\mathbf{w}^{*T} \mathbf{d} \mathbf{d}^{*T} \mathbf{w}} \quad (9)$$

where  $\mathbf{w}$  is defined as:  $\mathbf{w} = [1 \ e^{j\omega_1} \ \dots \ e^{j(N-1)\omega_1}]^T$

Since each of the elements of the signal vector is orthogonal to the noise subspace, the quantity (9) exhibits sharp peaks at the signal component frequencies.

In order to adapt this high-resolution method for analysis of non-stationary signals we use similar approach as in short-time Fourier transform (STFT). The time varying signal is broken up into minor segments (with the help of the temporal window function) and each segment (possibly overlapping) is analysed.

The denominator of (9) is estimated for the each time instant. Instantaneous estimates of (9) can be used as estimates of the instantaneous frequency of the signal [4].

## V. INVESTIGATIONS

### A. Switching of Capacitor Banks

In the paper, investigation results in a distribution system as in Fig. 1 are shown. Two capacitor banks (CB) were installed along the feeder. Several cases were simulated and both currents and voltages were recorded. Fig. 2 shows the current waveform at the beginning of the feeder for the case that the first CB (900 kVAr) was switched on at 0.03s and the second CB (1200 kVAr) at 0.09s.

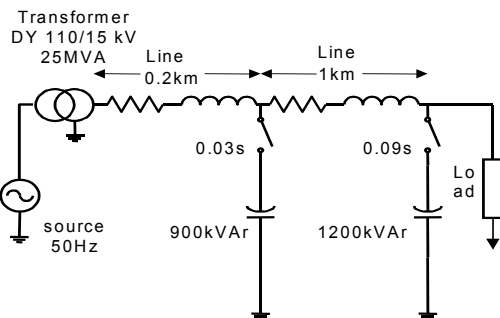

Fig. 1 One-phase diagram of the simulated system.

Applying the Wavelet Transform a scalogram has been obtained (Figs. 3, 4, 5), which enables to detect three signal components: the basic component (50 Hz) and two transient components (272 Hz and 478 Hz).

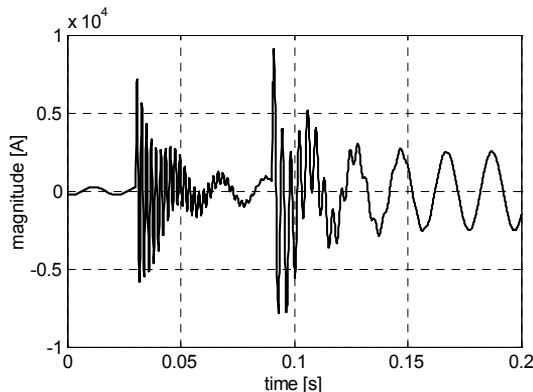

Fig. 2. Current waveform at the beginning of the feeder during subsequent switching of two capacitor banks.

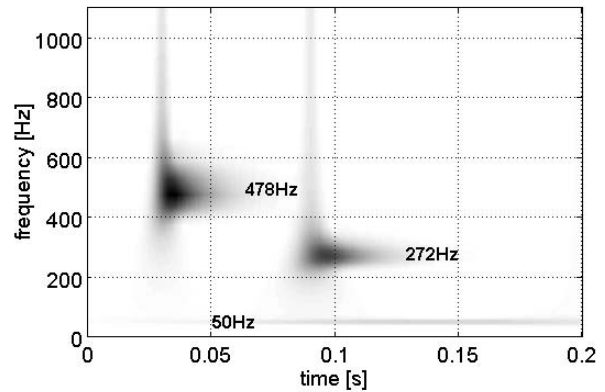

Fig. 3. Time frequency representation of the signal taken from switching of the capacitor banks, obtained using the Complex Morlet Wavelet,  $f_B=1$ ;  $f_C=5$ , scale=9:2:300.

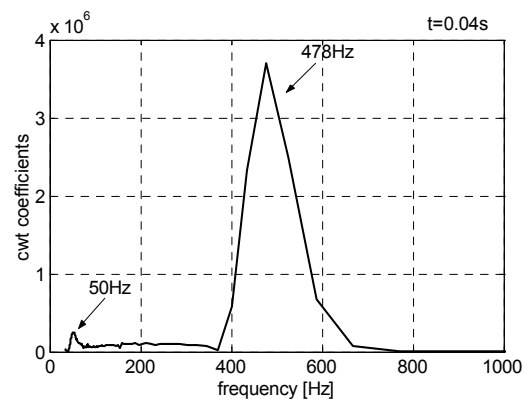

Fig. 4. Cross-section of the time-frequency representation from Fig. 3 for the time  $t=0.04$  s

Wigner-Ville Distribution offers the possibility to track the frequency and amplitude changes of a non-stationary signal. When applying the WVD for analysing the current signal in Fig. 2, the components 50 Hz, 270 Hz and 475 Hz have been detected (Figs. 6, 7, 8), which are closed to the results obtained by Wavelet Transform. However, appearance of cross-terms (110 Hz and 160 Hz) is difficult to explain. The Wigner-Ville representation allows immediate determination of the time point of the commutation incipience.

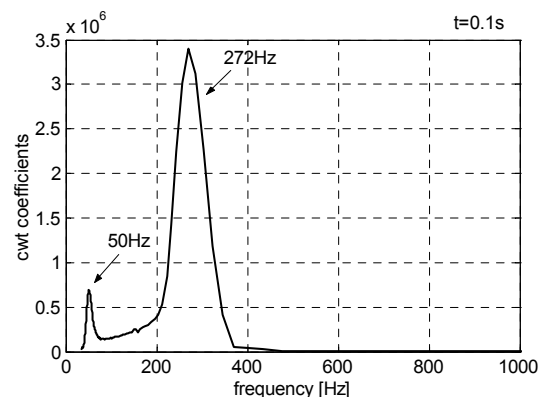

Fig. 5. Cross-section of the time-frequency representation from Fig. 3 for the time  $t=0.1$  s

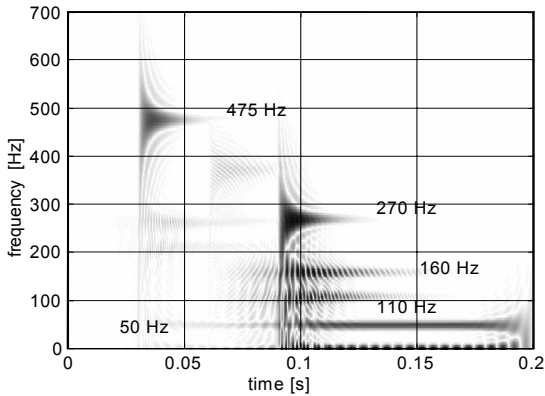

Fig. 6. Time frequency representation of the signal from Fig. 1 (switching of the capacitor banks), obtained using the Wigner-Ville Distribution (with Gaussian smoothing).

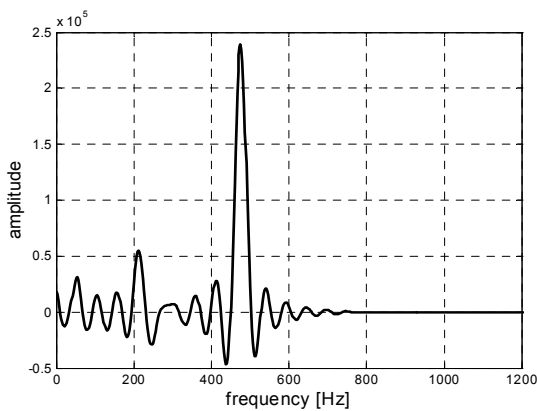

Fig. 7. Cross-section of the time-frequency representation from Fig. 6 for the time  $t=0.04$  s.

### B. Fault operation of the Inverter Drive

In the paper we show investigation results of a 3kVA-PWM-converter with a modulation frequency of 1 kHz supplying a 2-pole, 1 kW asynchronous motor (supply voltage 220 V, nominal power 1,1 kW, slip 6 %,  $\cos\phi=0.81$ ). (Fig. 9). Characteristic RC-damping components at the rectifier bridge and at the converter valves are considered. To design the intermediate circuit, the L, C values of a typical 3 kVA converter are chosen.

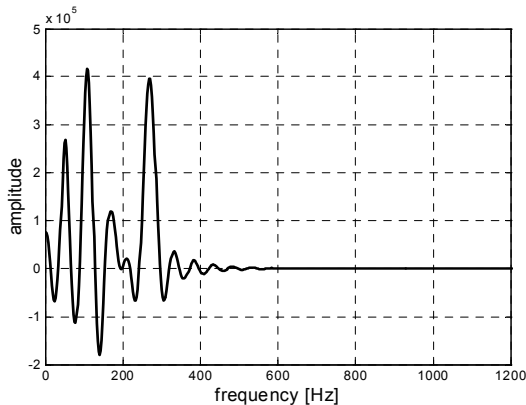

Fig. 8. Cross-section of the time-frequency representation from Fig. 6 for the time  $t=0.1$  s.

Fault operation of the inverter drive was considered short-circuit between motor leads which occurs at the time 0.1 s (Fig. 10) Main frequency of the inverter 60 Hz, sampling frequency 20 kHz.

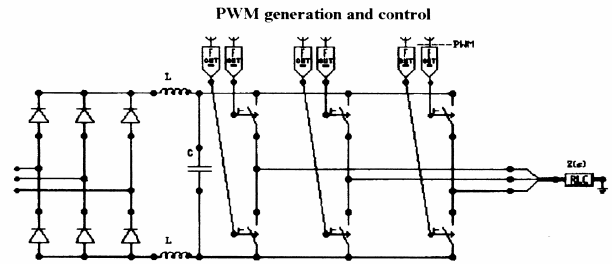

Fig. 9. Diagram of the simulated inverter drive.

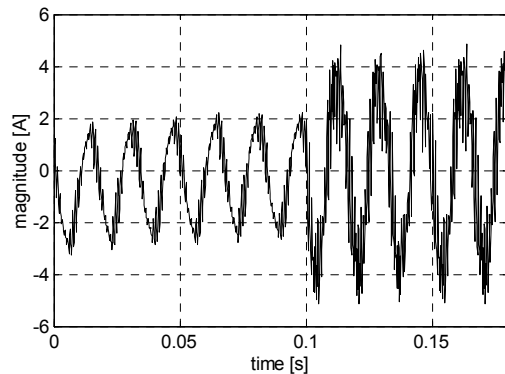

Fig. 10. Current waveform at the inverter output.

The current signal spectrum has been calculated using the Wavelet Transform (Figs. 11, 12, 13), Min-Norm subspace method (Figs. 14, 15) and the Wigner-Ville Distribution (Figs. 16, 17, 18). The WT enables to detect before the short circuit the short circuit the modulation frequency of the inverter equal to 1000 Hz. Where a short circuit occurs, we can see two modulation components (880 Hz and 1100 Hz) and an additional component with frequency 1930 Hz. In the case after the short circuit appears, the Min-Norm method enables to detect two intermodulation frequencies (880 Hz and 1120 Hz), and two additional components (1920 Hz and 2070 Hz).

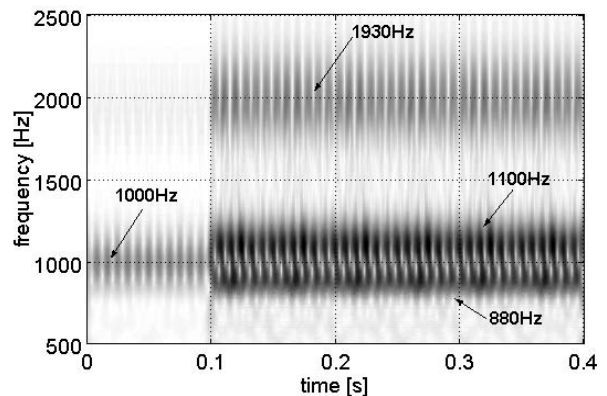

Fig. 11. Time frequency representation of the signal taken from the fault operation of the inverter drive, obtained using the Complex Morlet Wavelet,  $f_b=1$ ;  $f_c=1$ , scale=0.1:0.1:10.

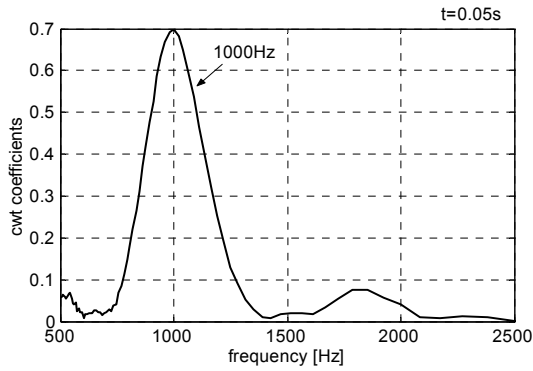

Fig. 12. Cross-section of the time-frequency representation from Fig. 11 for the time  $t=0.05$  s.

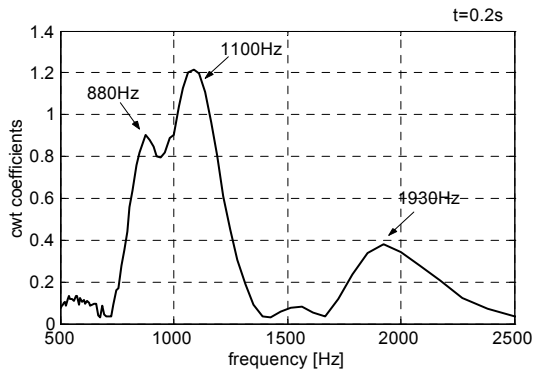

Fig. 13. Cross-section of the time-frequency representation from Fig. 11 for the time  $t=0.2$  s.

Due to its high-resolution properties, the Min-Norm method is especially suitable for identification and frequency estimation of signal components, which frequencies differ slightly. Detection of the additional higher frequency component can be applied as the fault indicator. The results obtained when using WVD are not satisfactory (Fig. 16, 17, 18). Before and after the fault appears the basic component, which has been detected. The modulation components (1000 Hz) has been detected only after the fault appearance, when the amplitude of the component is high enough. Unfortunately, the appearance of non-existent component of about 500 Hz becomes evident.

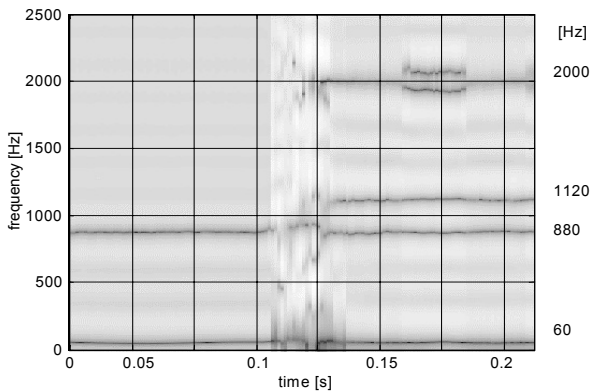

Fig. 14. Time frequency representation of the signal taken from fault operation of the frequency converter, obtained using the Min-Norm method. (window length 80 samples, sampling frequency 20 kHz).

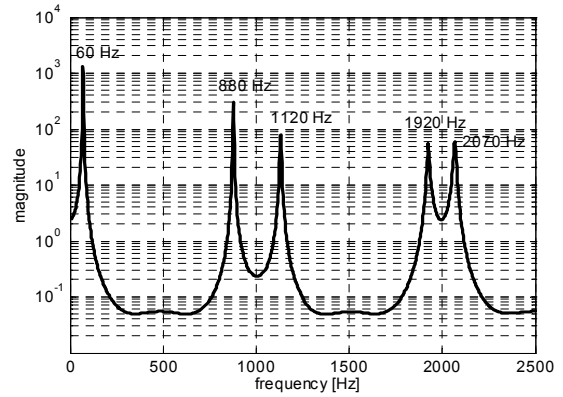

Fig. 15. Cross-section of the time-frequency representation from the Fig. 14 for the time  $t=0.17$  s.

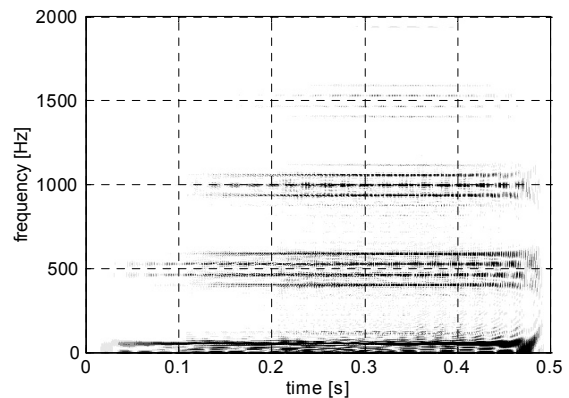

Fig. 16. Time frequency representation of the signal taken from the fault operation of the frequency converter, obtained using the Wigner-Ville Distribution (with Gaussian smoothing).

The cross-term interference components appear at frequencies which lie between the frequencies of two strong components. The amplitude of these components is often oscillating (as in Fig. 6 for the components with frequencies 110 and 160 Hz). As already mentioned, the way of lowering cross-term interference is to apply a low-pass filter to the WVD. In practical situations it does not always remove all artefacts and reduces the frequency resolution.

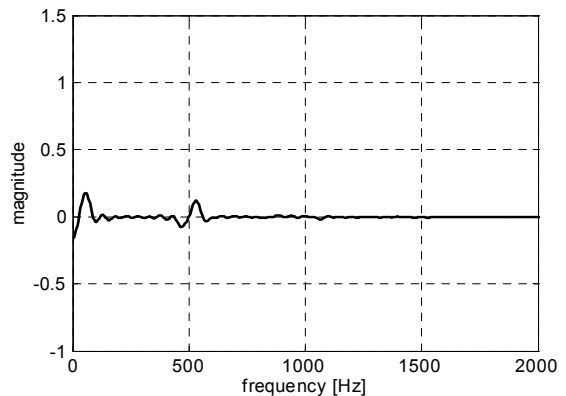

Fig. 17. Cross-section of the time-frequency representation from the Fig. 16 for the time  $t=0.05$  s.

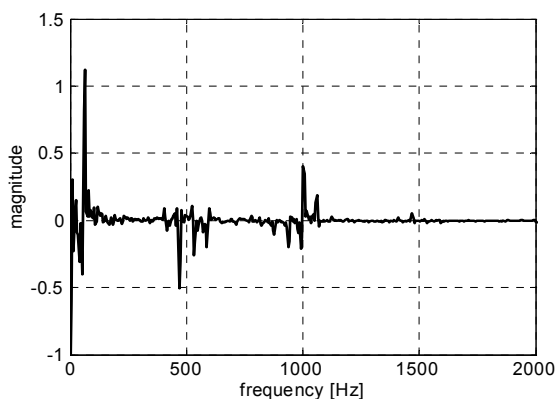

Fig. 18. Cross-section of the time-frequency representation from the Fig. 16 for the time  $t=0.2$  s.

## VI. CONCLUSIONS

Transients resulting from the switching capacitor banks and fault operation of the frequency converter in electrical distribution systems affect power quality. Modern frequency power inverters generate a wide spectrum of harmonic components. Detection of all signal components can be effectively used to identify faults in inverter. The parameters of transient components have been analyzed using the Wigner-Ville distribution, wavelets and subspace methods. The Wigner-Ville spectrum of signals with time limited windows shows better frequency concentration and less phase dependence than Fourier spectra. The investigations show the advantages of the method basing proposed methods. However, the Wigner-Ville distribution offers advantages when analyzing signals with few components. It allows in the case of the signal obtained during switching of capacitor banks, immediate determination of the time point of the commutation incipience and amplitudes of respective components.

In the case of multi-component signals (frequency converter), due to the appearance of cross-terms, obtained representation is difficult to interpret. By comparing the Wigner-Ville and min-norm representation the appearance of non-existent component of about 500 Hz becomes evident. In this case better results gives the subspace method, which allows the determination of the frequencies of the spectral components with high accuracy and does not suffer from the appearance of artifacts. Due to its high-resolution properties, the Min-Norm method is especially suitable for identification and frequency estimation of signal components, which frequencies differ slightly.

## ACKNOWLEDGMENTS

This work was supported by the State Committee for Scientific Research (Poland) under Grant No. 4T10A00423.

## REFERENCES

- [1] R. Baraniuk, D. Jones: "A signal dependent time-frequency representation: optimal kernel design", *IEEE Trans. on Signal Processing*, 41, pp. 1589-1602, 1993.
- [2] S. M. Kay: *Modern spectral estimation: Theory and applications*, Englewood Cliffs: Prentice-Hall, 1988.
- [3] Z. Leonowicz, T. Lobos: "Analysis of Three-Phase Signals Using Wigner Spectrum". XVI IMEKO World Congress, Vienna 2000, vol. VI, pp. 215-220.
- [4] T. Lobos, Z. Leonowicz, J. Rezmer : "Harmonics and Interharmonics Estimation Using Advanced Signal Processing Methods". 9<sup>th</sup> IEEE Int. Conf. on Harmonics and Quality of Power, Orlando (USA), 2000, vol. I, pp. 335-340.
- [5] W. Martin, P. Flandrin P.: "Wigner-Ville Spectral Analysis of Non-stationary Processes", *IEEE Trans. on Acoustics, Speech and Signal Processing*, vol. 33, no. 6, pp. 1461-1470, 1985.
- [6] S. Quian, D. Chen: *Joint Time-Frequency Analysis - Methods and Applications*, Prentice-Hall, Upper Saddle River, NJ, pp. 101-131, 1996.
- [7] O. Rioul, V. Martin: "Wavelets and Signal Processing", *IEEE SP Magazine*, pp. 14-38, October 1991.