

EVALUATION OF COMPENSATION DEVICES OF DC ARC FURNACES USING ADVANCED SPECTRUM ESTIMATION METHODS

A. Bracale*, G. Carpinelli*, Z. Leonowicz**, T. Lobos**, J. Rezmer**

* Università degli Studi di Napoli "Federico II", Napoli – Italy

** Wrocław University of Technology, Wrocław – Poland

tadeusz.lobos@pwr.wroc.pl

Abstract – Spectral representation of waveform distortions has been of great interest in power systems for many years since the disturbing loads generate a wide spectrum of components which deteriorate the quality of power supply. When spectral components are time-varying in amplitude and/or in frequency – such as in presence of arc furnaces and adjustable speed drives - high resolution methods should be applied due to their capability of capture these changes in time. In this paper the Prony and ESPRIT high-resolution methods are used to analyse simulated non-stationary waveforms in a supply system of a DC arc furnace. The analysis has been completed before and after the inclusion in the system of several compensation devices (STATCOM, Active Filter, Passive Filter and a hybrid of STATCOM and Active Filter). The main conclusion of the paper is that Prony and ESPRIT methods are useful tools also for the control system design; in fact, they allow capturing time variations of spectra components better than most usual techniques such as Fourier-based methods.

Keywords: DC Arc Furnaces, STATCOM, Active Filters, Non-stationary Signal Analysis, Prony Method, ESPRIT

1 INTRODUCTION

The quality of power supply is very important nowadays. The dc arc furnaces, among others, generate a wide spectrum of harmonics (sometimes interharmonics, considered as more damaging) which deteriorate the quality of the delivered energy, increases the energy losses and decreases the reliability of a power system. The correct design of compensation devices and assessment of the efficiency of compensation relies on the measurement of distortions in both current and voltage waveforms.

There are many different approaches for measuring harmonic distortion, like FFT, application of adaptive filters, neural networks, etc. which can provide unreliable results because of strong assumptions about the signal which are often not satisfied. Moreover, the signal spectral components are often time-varying in amplitude and/or in frequency. The case of a dc arc furnace plant is particularly difficult because the influence of an ac/dc static converter and mainly random motion of electric arc - as a time-varying and non-linear load which is responsible for strong perturbations - cause waveform distortions and voltage fluctuations.

Modern spectrum estimation methods can provide in this case more reliable results of investigation because of high-accuracy even for short data lengths, immunity to noise and independence of accuracy on length of analysis window and on other signal parameters [1 - 3].

Current and voltage waveforms are obtained from a simulated dc arc furnace plant with and without compensation devices, such as: passive filters, active filters, static synchronous compensator (STATCOM) and a hybrid of active filter and STATCOM [4].

Analysis of current and voltage waveforms is carried out using the Prony model and ESPRIT method. All above methods are parametric high-resolution spectral methods, which can provide time-varying values of amplitude and/or frequency of spectral components.

In the paper, numerical applications of these methods are presented in order to illustrate their implementation problems and practical applications. To investigate the methods, several experiments are performed using non-stationary voltage and current waveforms in a supply system of a dc arc furnace with different compensation devices. Conclusions and recommendations are formulated concerning each of the compensation and investigation methods.

2 MODEL OF DC ARC FURNACE WITH COMPENSATION DEVICES

A typical dc arc furnace plant, shown in Fig. 1, was modelled using Power System Blockset in Matlab®. The electric arc was simulated with a Chua circuit, which shows good similarity with real measurements [4, 5].

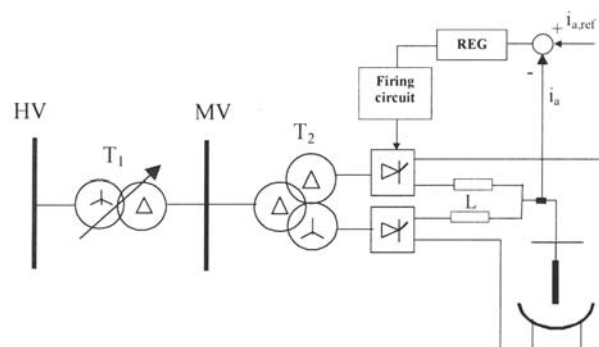

Figure 1: Modelled dc arc furnace plant.

The system shown in Fig. 1 has the following parameters [4]:

<u>PCC</u>	
Short-circuit apparent power:	3500 MVA
Rated voltage:	220 kV
<u>Transformer T1</u>	
Rated power:	80 MVA
Rated voltage:	220kV/21kV
Vcc	8%
Winding connection:	Y-Δ
<u>Transformer T2</u>	
Rated power:	87 MVA
Rated voltage:	21kV/0,638kV/0,638kV
Vcc	10,37%
Winding connection:	Y-Δ-Δ
<u>Interphase reactor</u>	150 μH
<u>Arc furnace rated current</u>	96 kA.

The dc furnace generates severe harmonic and inter-harmonic distortions as well as voltage fluctuations and requires the application of compensation devices. In the FFT spectrum of the currents and voltages, groups of spectral components appear which can be divided into *characteristic harmonics* due to twelve-pulse rectifier and *characteristic interharmonics* around them which appear as the consequence of the arc fluctuations; around the fundamental frequency component can also appear *fundamental interharmonics* due to active and reactive power fluctuations [4].

Several compensation devices were considered: Active and Passive filters, STATCOM and a hybrid of Active Filter and STATCOM. The design of all the active compensation device control systems was effected on the basis of the results obtained applying to the compensated waveforms a Fourier-based method on a 1 s window (1 Hz resolution frequency) [1,4]. The influence of the length of the analysis window is thoroughly analysed in [1].

2.1 Active Filters

The configuration of active filters is based on PWM voltage-source inverter connected in parallel with the furnace inverter. It employs the compensation strategy of the characteristic harmonics and characteristic interharmonics by using the sum of high frequency d - and q - axis components of the DC arc furnace current as reference. The main advantage of active filters is efficient compensation of high-frequency distortions.

2.2 Passive Filters

The passive filter includes two notch filters tuned at 600 and 1150 Hz, to eliminate the main characteristic harmonics and interharmonics. A third filter tuned at 250 Hz reduces the resonance between two main filters.

2.3 STATCOM

The static synchronous compensator (STATCOM) aims at compensation of the fluctuations of the reactive power by the generation of three phases balanced voltages at the fundamental frequency. Its advantage is in efficient compensation of slow voltage variations.

2.4 Active Filter and STATCOM

STATCOM highest performance is in compensation of slow voltage variations whereas active filters perform better in compensation of high-frequency distortions. The application of both devices combines their advantages.

3 HARMONIC DECOMPOSITION METHODS

The Prony method represents the sampled data as a linear combination of exponentials while ESPRIT bases on the model of sum of exponentials with additive noise [6, 10].

3.1 Prony Method

Assuming N data samples $[x_1 \ x_2 \ \dots \ x_N]$ the investigated waveform can be approximated by M exponential functions:

$$y[n] = \sum_{k=1}^M A_k e^{(\alpha_k + j\omega_k)(n-1)T_s + j\phi_k} \quad (1)$$

where $n = 1, 2, \dots, N$, T_s – sampling period, A_k – amplitude, α_k – damping factor, ω_k – angular velocity, ϕ_k – initial phase.

The Toeplitz matrix created from samples makes it possible to determine the vector of coefficients \mathbf{a} of the characteristic polynomial:

$$z^M + a_1 z^{M-1} + \dots + a_{M-1} z + a_M = 0. \quad (2)$$

The roots of the characteristic polynomial define the Vandermonde matrix:

$$\mathbf{Z} = \begin{bmatrix} \mathbf{z}_1^0 & \dots & \mathbf{z}_{M-1}^0 & \mathbf{z}_M^0 \\ \mathbf{z}_1^1 & \dots & \mathbf{z}_{M-1}^1 & \mathbf{z}_M^1 \\ \vdots & \vdots & \vdots & \vdots \\ \mathbf{z}_1^{M-1} & \dots & \mathbf{z}_{M-1}^{M-1} & \mathbf{z}_M^{M-1} \end{bmatrix} \quad (3)$$

Vector of complex values \mathbf{H} can be calculated from:

$$\mathbf{Z} \cdot \mathbf{H} = \mathbf{X} \quad (4)$$

where

$$\mathbf{X} = [x_1 \ x_2 \ \dots \ x_M].$$

Parameters of exponential components for $k=1, 2, \dots, M$ can be calculated from:

$$A_k = |\mathbf{h}_k| \quad \text{amplitude,}$$

$$\alpha_k = f_s \cdot \ln |\mathbf{z}_k| \quad \text{damping factor,}$$

$$\omega_k = f_s \cdot \arg(\mathbf{z}_k) \quad \text{angular velocity.}$$

$$\phi_k = \arg(\mathbf{h}_k) \quad \text{initial phase.}$$

3.2 TLS-ESPRIT-based decomposition

The original ESPRIT algorithm [10] is based on naturally existing shift invariance between the discrete time series, which leads to rotational invariance between the corresponding signal subspaces.

The assumed signal model is the following:

$$y[n] = \sum_{k=1}^M A_k e^{j\omega_k n} + w[n] \quad (5)$$

where $w[n]$ represents additive noise. The eigenvectors \mathbf{U} of the autocorrelation matrix of the signal define two subspaces (signal and noise subspaces) by using two selector matrices $\mathbf{\Gamma}_1$ and $\mathbf{\Gamma}_2$ [7].

$$\mathbf{S}_1 = \mathbf{\Gamma}_1 \mathbf{U} \quad \text{and} \quad \mathbf{S}_2 = \mathbf{\Gamma}_2 \mathbf{U} \quad (6)$$

The rotational invariance between both subspaces leads to the equation:

$$\mathbf{S}_1 = \mathbf{\Phi} \mathbf{S}_2 \quad (7)$$

where:

$$\mathbf{\Phi} = \begin{bmatrix} e^{j\omega_1} & 0 & \dots & 0 \\ 0 & e^{j\omega_2} & \dots & 0 \\ \vdots & \vdots & \ddots & \vdots \\ 0 & 0 & \dots & e^{j\omega_M} \end{bmatrix}$$

The matrix $\mathbf{\Phi}$ contains all information about M components' frequencies. Additionally, the TLS (total least-squares) approach assumes that both estimated matrices \mathbf{S} can contain errors and finds the matrix $\mathbf{\Phi}$ as minimization of the Frobenius norm of the error matrix. Amplitudes of the components can be found in similar way as with Prony method using (5).

The analysis of non-stationary signals requires a similar approach as in short-time Fourier transform (STFT). The time varying signal is broken up into minor segments with the help of the temporal window function and each segment (with overlapping) is analysed.

ESPRIT method is known to be a very accurate and low-complexity algorithm; it is also claimed as being not adversely affected by the wrong estimation of the model order (number of components M) [7].

4 INVESTIGATIONS AND DISCUSSION

The Prony and ESPRIT methods have been applied to analyse the simulated waveforms of the dc arc furnace in Fig. 1, without and with the compensation devices described in Sections from 2.1 to 2.4.

Some of the obtained results will be presented in the next part; they refer to the voltage at MV busbar. The results of Prony method are concentrated on the funda-

mental component while a wide range of results of ESPRIT method is also shown.

Prony method was also used as tool for confirmation of the correctness of ESPRIT analysis. ESPRIT and Prony methods are based on different assumptions and algorithms. Nevertheless the results of analysis of strongly distorted signals show very good similarity when using both methods.

4.1. Fundamental component analysis with Prony method

In Figures from 2 to 4 the voltage fundamental component amplitudes versus time are shown; they refer to the dc arc without compensation (Fig. 2), with STATCOM (Fig. 3) and with Active Filter (Fig. 4) devices. Also the spectra obtained with an FFT with 1 s window are reported.

Table 1 shows the fundamental amplitude fluctuations obtained without compensation and with all the compensation devices described in Section 2. Amplitude fluctuations were calculated as the relative difference between maximum and minimum values to the average value over the analysis interval.

On the basis of the FFT spectra (1 s window, 1 Hz frequency resolution) it can be observed that all the active devices seem to operate with acceptable compensation characteristics, even if the control systems are not optimized.

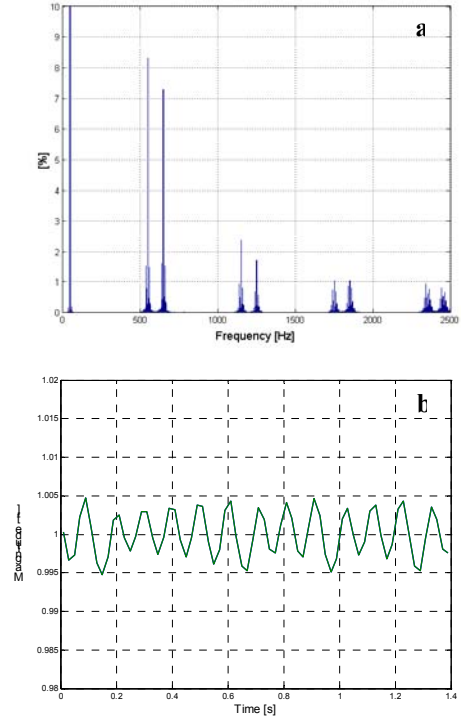

Figure 2: Voltage at the DC arc furnace without compensation: a) spectrum (FFT on 1 s window); b) fundamental component's magnitude versus time (PRONY representation for 100 samples in window analysis, sampling frequency 5000 Hz).

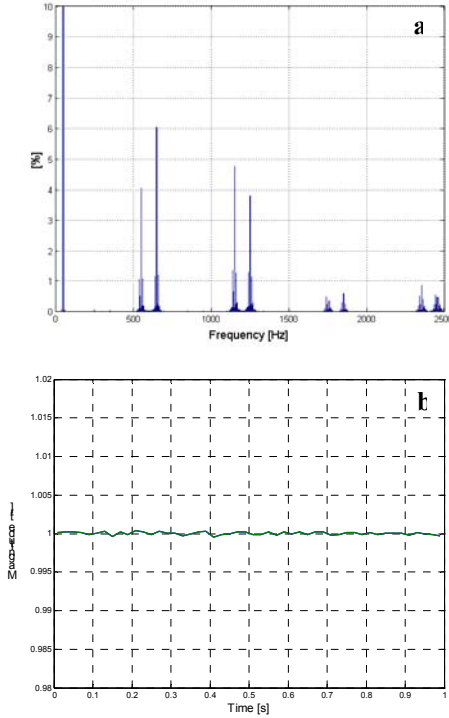

Figure 3: Voltage at the DC arc furnace with STATCOM: a) spectrum (FFT on 1 s window); b) fundamental component's magnitude versus time (PRONY representation for 100 samples in window analysis, sampling frequency 5000 Hz)

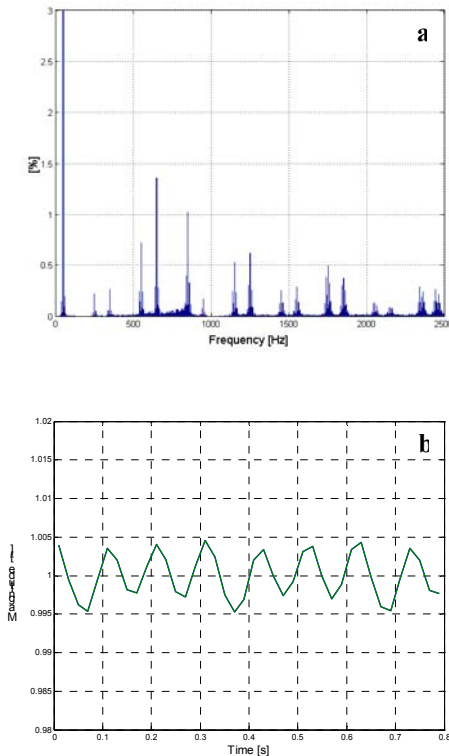

Figure 4: Voltage at the DC arc furnace with Active Filter: a) spectrum (FFT on 1 s window); b) fundamental component's magnitude versus time (PRONY representation for 100 samples in window analysis, sampling frequency 5000 Hz)

Compensation Method	Amplitude fl. [%]
No Compensation	0.98
Active Filter	1.01
STATCOM	0.09
Passive Filters	0.80
STATCOM – Active Filter	0.21

Table 1: Selected results of the Prony analysis at the fundamental component.

However, the analysis with Prony method reveals that the active filter compensation of harmonic distortions can lead to very slight increased fluctuation of the voltage at fundamental frequency. Moreover, while it confirms the good action of the STATCOM in reducing the fluctuations at fundamental frequency, it also evidences that the combination of STATCOM and active filter (in comparison to STATCOM only) makes worse the amplitude stability as consequence of active filters performance in amplitude stabilisation. Finally, the fluctuations in presence of passive filters reduce, due to a better performance of the AC/DC control system [1].

It should be noted that very small fluctuations of the fundamental frequency have been also detected. Their values strictly depend on the number of components and samples considered in the Prony method application.

4.2. ESPRIT detailed analysis

In the first step the power spectra of all available signals were computed and the 'regions of interest' in the spectrum were chosen considering a 9 component model. The corresponding representation obtained with ESPRIT method is shown in Fig. 5, in the case without compensation.

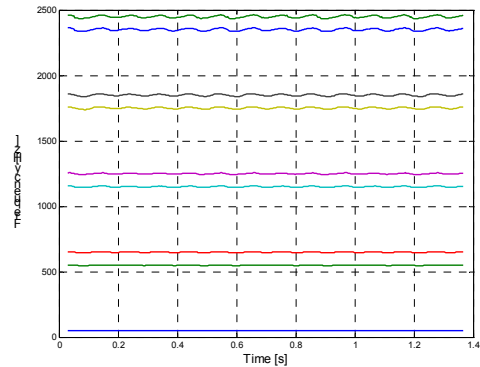

Figure 5: ESPRIT representation of the MV voltage at the DC arc furnace without compensation. Analysis window of 300 samples (sampling frequency 5000 Hz).

The following bands will be analysed in detail in the next: fundamental band (30-70 Hz), the band containing the 11th and 13th harmonic (450-750 Hz) and the high-frequency band containing the 35th and 37th harmonic (1600-2000 Hz).

4.2.1 Fundamental band

The band 30-70 Hz containing the fundamental harmonic was filtered using 6th order Butterworth band-pass filter. Tab. 2 shows the fundamental amplitude fluctuations obtained without compensation and with all the compensation devices described in Section 2.

Compensation Method	Amplitude fl. [%]
No Compensation	0.80
Active Filter	0.80
STATCOM	0.05
Passive Filters	0.62
STATCOM – Active Filter.	0.08

Table 2: Amplitude fluctuations calculated by ESPRIT method over a 1 s interval at fundamental frequency. Analysis window of 250 samples (sampling frequency 5000 Hz).

From the analysis of Table 2 it follows that the STATCOM compensator has the best performance of amplitude stabilisation (compensation of reactive power exchange at fundamental). ESPRIT method confirms that combination of STATCOM and active filters makes worse the amplitude stability.

It can be observed that the results in Tables 1 and 2 are not closely the same, but the tendency is very similar and depending on the number of samples and components taken into account in the method application. Moreover, it should be noted that also the ESPRIT method furnished very small frequency fluctuations at fundamental.

4.2.2. Band containing the 11th and 13th harmonics (450-750 Hz)

The power spectrum shows two characteristic harmonics in this band, corresponding to characteristic harmonics of the twelve-pulse rectifier ($h=12k\pm 1$; $k=1$). In order to investigate them closely, the band-pass filter of 450-750 Hz was applied.

Table 3 shows the harmonic amplitude and frequency fluctuations obtained without compensation and with all the compensation devices described in Section 2. The amplitudes of the 11th and 13th harmonics averaged over the analysis interval are also shown.

At first, it can be observed that the passive filters offer the best performance in term of both compensation action and reduced fluctuations; the STATCOM presence modifies the voltage quality as a consequence of its self-generated 11th and 13th harmonics.

All the active compensation devices seem to cause significant fluctuations of investigated components, especially active filter (Fig.6). Really, these fluctuations almost always refer to harmonic values significantly lower than the ones in case of no compensation and they could be due to a slow time reaction of the control systems. Moreover, it should be noted that the active filter operates with a hysteretic current control whose reference signal includes the sum of the not fundamen-

tal frequency components of the dc arc furnace current; then, the control system operates with the aim of compensating the distortions as a whole and not the single components separately.

Compens. Method	550 Hz harm.			650 Hz harm.		
	Freq. fl. [%]	Amplitude* [%]	Ampl. fl. [%]	Freq. fl. [%]	Amplitude* [%]	Ampl. fl. [%]
No Com.	1.1	8.7	7.6	1.1	7.8	9.1
Active f.	2.4	0.9	86.4	1.0	1.5	80.2
Pass. F.	0.9	0.6	10.0	0.9	0.7	15.2
STAT.	1.6	4.4	43.0	1.0	6.3	36.5
STAT.Af	1.7	1.9	48.0	1.0	2.7	39.8

Table 3: Frequency and amplitude fluctuations calculated by ESPRIT method over a 1 s interval at 11th and 13th harmonic. Amplitude* is calculated as ratio of the current component amplitude to the amplitude of the fundamental component (both averaged over the analysis interval).

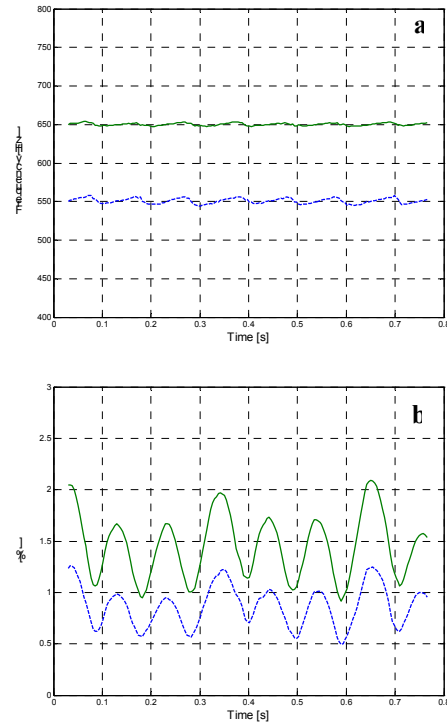

Figure 6: Time-varying frequency (a) and relative amplitude (b) (relative to the mean amplitude over the analysis interval) of MV voltage with active filters at 11th and 13th harmonic.

Finally, it should be noted that Prony and ESPRIT methods were characterized by closer results in all the cases, where generally these two methods underline harmonic amplitudes greater than the ones obtained with FFT.

4.2.3. High-frequency band containing the 35th and 37th harmonics (1600-2000 Hz)

The band 1600-2000 Hz contains two strong components. One of them can be regarded as the 37th harmonic

(1850 Hz), the other as a 35th harmonic (1750 Hz). Both components have approximately equal amplitudes.

Table 4 shows once gain the harmonic amplitude and frequency fluctuations obtained without compensation and with all the compensation devices described in Section 2; amplitudes of the 35th and 37th harmonics averaged over the analysis interval are also shown. Figure 7 shows the time-varying frequency and relative amplitude of the MV voltage without compensation of the 35th and 37th harmonics.

Compens. Method	1750 Hz harm.			1850 Hz harm.		
	Freq. fl. [%]	Amplitude* [%]	Ampl. fl. [%]	Freq. fl. [%]	Amplitude* [%]	Ampl. fl. [%]
No Com.	1.2	1.8	52.1	1.1	2.0	38.0
Active f.	1.3	0.9	64.4	1.3	0.7	69.3
Pass. F.	0.9	0.3	16.4	0.9	0.2	17.6
STAT.	0.9	0.9	80.0	0.7	0.8	130
STAT.Af	1.3	1.4	38.4	1.0	1.0	19.4

Table 4: Frequency and amplitude fluctuations calculated by ESPRIT method over a 1 s interval at 35th and 37th harmonic. Amplitude* is calculated as ratio of the current component amplitude to the amplitude of the fundamental component (both averaged over the analysis interval).

It can be observed that passive filters compensate most of the higher harmonics and offer also best amplitude stability. All other compensation devices influence both components equally with the STATCOM that seems to cause the strongest fluctuations of the 35th and of the 37th harmonic.

Similar considerations as the ones effected in Section 4.2.2 on the amplitude values in presence of compensation devices and on the control system action can be formulated.

5. CONCLUSIONS

In this paper the theoretical aspects of some high-resolution methods for the analysis of non-stationary waveforms in power systems have been shown. They are Prony and ESPRIT methods which can be useful tools not only to detect the time-varying nature of the spectral components amplitudes but also for the calculation of the behaviour of the frequencies of signal components versus time.

The methods have been applied to analyse the non-stationary simulated waveforms of a typical DC arc furnace plant. The analysed waveforms concern the voltage and current before and after the inclusion in the system of several compensation devices. Even if Prony and ESPRIT methods are based on different assumptions and algorithms, they showed similar results.

They clearly revealed significant fluctuations in time of harmonics, whose mean values in presence of

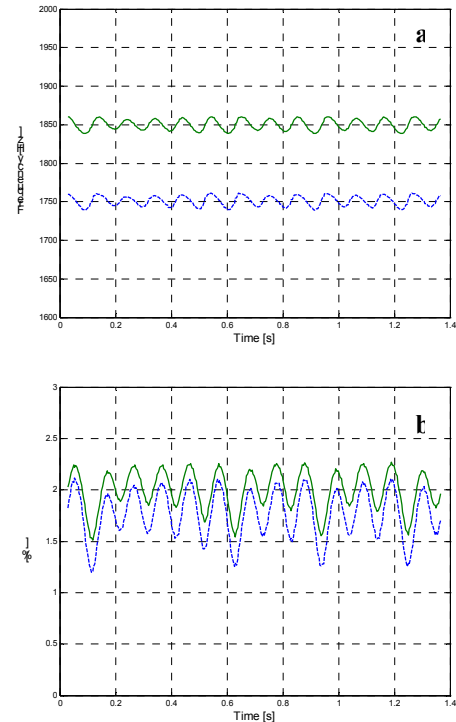

Figure 7: Time-varying frequency (a) and relative amplitude (b) (relative to the mean amplitude over the analysis interval) of MV voltage without compensation at the 1600-2000 Hz band.

compensation devices are greater than the ones obtained with the application of a FFT-based method on a 1 s window (1 Hz frequency resolution). Then, the use of the considered high-resolution methods should be taken into account in an optimized design not only of the compensation device control systems but also of the arc furnace AC/DC converter control system.

ACKNOWLEDGEMENT

This work was supported in part by the State Committee for Scientific Research KBN (Poland) under Grant No. 8T10A00423.

REFERENCES

- [1] A. Bracale, G. Carpinelli, Z. Leonowicz, T. Lobos, J. Rezmer, "Waveform Distortions due to AC/DC Converters Feeding Dc Arc Furnaces", Trans. of EPQU 05 Conference, Cracow, Poland, 2005, submitted.
- [2] Z. Leonowicz, T. Lobos and J. Rezmer, "Advanced Spectrum Estimation Methods for Signal Analysis in Power Electronics": IEEE Trans. on Industrial Electronics, vol. 50, no. 3, 2003, pp 514-519.
- [3] T. Lobos., Z. Leonowicz and J. Rezmer, "Harmonics and Interharmonics Estimation Using Advanced Signal Processing Methods", 9th IEEE Int. Conf. on Harmonics and Quality of Power, Orlando (USA) 2000, vol. I, pp. 335-340.

- [4] G. Carpinelli and A. Russo, "Comparison of Some Active Devices for the Compensation of DC Arc Furnaces", IEEE Bologna PowerTech Conf., 2003, Bologna (Italy), Session: Active filters, paper BPT03-458
- [5] G. Carpinelli, F. Iacovone, A. Russo, P. Verde and D. Zaninelli, "DC Arc Furnaces: Comparison of Arc Models to Evaluate Waveform Distortions and Voltage Fluctuations", Proc. 2001 IEEE PES 33th Annual North American Power Symposium (NAPS), College Station (Texas), 2001, pp. 574-580.
- [6] C.J. Daffs, C.O. Nwankpa and A. Petropulu, "Harmonic Decomposition of Transient Disturbances using the LS Prony and ESPRIT-based Methods, 14th PSCC Proceedings, session 28, paper 2, June 2002.
- [7] J. Kusuma: "Parametric Frequency Estimation: ESPRIT and MUSIC", Rice University, <http://cnx.rice.edu/content/m10588/>, 2002.
- [8] M.R. Osborne and G.K. Smyth, "A Modified Prony Algorithm for Exponential Function Fitting", SIAM J. Sci. Statist. Comput., vol. 16, pp. 119-138.
- [9] R. Roy and T. Kailath, "ESPRIT - Estimation of Signal Parameters via Rotational Invariance Techniques", IEEE Transactions on Acoustics, Speech, and Signal Processing, Vol. ASSP-37, (1989), pp. 984-995.
- [10] C. W. Therrien, "Discrete Random Signals and Statistical Signal Processing", Prentice Hall, Englewood Cliffs, New Jersey, 1992.