

Analysis of Mathematical Modeling of PV Module with MPPT Algorithm

B.Chitti Babu, *Member, IEEE*
Tomas Cermak, *Member, IEEE*
Centrum ENET, VSB-
Technical University of
Ostrava, Czech Republic
dr.chittibabub.b@ieee.org,
tomas.cermak@vsb.cz

Suresh Gurjar
Department of Electrical
Engineering, National
Institute of Technology
Rourkela,
India
sureshgjr91@gmail.com

Zbigniew M. Leonowicz,
Senior Member, IEEE
Faculty of Electrical
Engineering, Wroclaw
University of Technology,
Poland
leonowicz@ieee.org

Luigi Piegari
Senior Member, IEEE
Department of Electronics,
Information and
Bioengineering,
Politecnico di Milano,
Italy
luigi.piegari@polimi.it

Abstract—This paper presents the mathematical modeling of photovoltaic (PV) module with the effective comparison of two popular maximum power point tracking (MPPT) techniques namely. Generally, Maximum Power Point Tracking (MPPT) techniques are used in PV System to extract maximum possible power which in turn depends on solar irradiance and temperature of PV module. Two most widely used MPPT techniques namely incremental conductance (INC), and perturb & observe (P&O) method are analyzed in this paper. The PV models compared are simplified single diode model, improved two diode model and simplified two-diode model. The effectiveness of the comparison has been done through MATLAB/Simulink Environment and the results are analyzed.

Index Terms—maximum power point tracking (MPPT) photovoltaic (PV) module, single-diode model, improved two-diode model, simplified-two diode model, modeling & simulation

I. INTRODUCTION

As the people are more concern about fossil fuel exhaustion and the environmental problems such as CO₂ emissions and global warming caused by the fuel fired power generation. As a result, renewable energy sources such as solar, wind, biomass etc., are playing pivotal role in cleaner power production. Nowadays, photovoltaic (PV) system, which makes possible electricity generation from solar energy, and can be used for both grid-connected and stand-alone applications. And also these are widely used for remote areas where electricity is not easily accesible [1]. Moreover, PV system is rapidly growing in the current market owing to cost effective power production, fast technological progress, being maintenance and clean power production. However, the efficiency of energy conversion largely depends on the efficiency of the PV system that generates the power. In exacting, atmospheric conditions highly influences the efficiency, which depends nonlinearly on the irradiation level and solar temperature and also these factors affect the output I-V and P-V characteristics of a PV module [2].

Generally the mathematical modeling and simulation of many individual components of PV system are presented in

available literature for better understanding of their performances. Moreover, it is necessary to model it to study the dynamic performance of PV system in the study of MPP tracking (MPPT) algorithms and to simulate the PV system and its components [3]-[4]. Now a days high efficiency power conditioner based on power converters are most widely employed to reduce the overall cost since PV modules still have relatively low conversion efficiency during low irradiation levels, In addition, power converters are designed to extract the maximum possible power from the PV module [5] though Maximum Power Point Tracking (MPPT) algorithm.

In this context, this paper presents the mathematical modeling of photovoltaic (PV) module with the effective comparison of two popular maximum power point tracking (MPPT) techniques namely. Generally, Maximum Power Point Tracking (MPPT) techniques are used in PV System to extract maximum possible power which in turn depends on solar irradiance and temperature of PV module. Two most widely used MPPT techniques namely incremental conductance (INC), and perturb & observe (P&O) method are analyzed in this paper. The PV models compared are simplified single diode model, improved two diode model and simplified two-diode model. The effectiveness of the comparison has been done through MATLAB/Simulink Environment and the results are analyzed.

II. MATHEMATICAL MODELING OF PV MODULE

A solar cell is basically a P-N junction fabricated in a thin wafer of semiconductor material such as Silicon or Germanium). When the solar cell is exposed to sunlight, due to electron-hole pair recombination, electricity is generated when the photon energy exceeds band-gap energy of semiconductor corresponding to the incident irradiation [6]. This effect is called photovoltaic effect. Generally, PV module composed of series and parallel combination of solar cells to provide demanded power range. Usually, the output current of PV module depends on photo current (I_{pv}) and exponential function of diode saturation current (I_0) and it can be expressed as follows.

$$I = I_{pv} - I_0 \left[\exp\left(\frac{q(V + IR_s)}{N_s K T A}\right) - 1 \right] - (V + IR_s)/(R_{sh}) \quad (1)$$

where,

- q= Electron charge (1.6x10⁻¹⁹ Coulombs)
- K=Boltzmann constant (1.38x10⁻²³ Nm/K)
- T=PV Module temperature in Kelvin
- I₀=Reverse saturation current of diode
- A=Diode ideality constant of diode
- I_{pv}=Light generated current of PV cell in Ampere
- R_s=Series Resistance of PV cell
- R_{sh}=Shunt Resistance of PV cell
- N_s=Number of PV module connected in series
- I=Output current of PV cell in Ampere

This section describes different mathematical models of PV module with mathematical expressions.

A. Ideal Single-Diode Model

In this model PV module is modeled as a current source and a diode in parallel as shown in Fig. 1 with negligible series and shunt resistances [7]. With reference to Fig.1 the I-V equation (1) becomes

$$I = I_{pv} - I_0 \left[\exp\left(\frac{q(V + IR_s)}{N_s K T A}\right) - 1 \right] \quad (2)$$

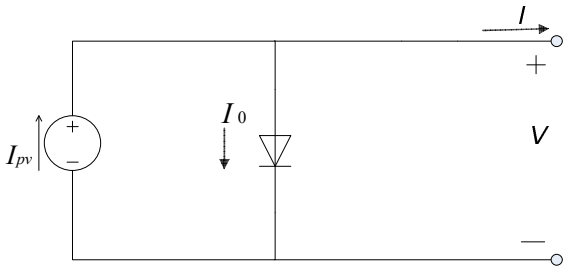

Fig. 1 Ideal Single Diode Model (ISDM)

Usually, this Model has three unknown parameters (I_{pv}, I₀ and A). I_{pv} is determined from the manufacturer datasheet as follows:

$$I_{pv} = G(I_{sc} + \alpha \Delta T) \quad (3)$$

Where G is irradiance (kW/m²), I_{sc} is short circuit current at STC (Standard Temperature Condition), ΔT is the temperature difference between the module temperature and the STC temperature and α is the current temperature coefficient given in the datasheet

I₀, Saturation Current can be expressed as follows:

$$I_0 = \frac{e^{\left(\frac{|\beta| \Delta T * q}{N_s K T A}\right)} G [I_{sc} + \alpha \Delta T]}{\left(G I_{sc} / I_{rs} + 1\right)^{\frac{T_o}{T}} - e^{\left(\frac{|\beta| \Delta T * q}{N_s K T A}\right)}} \quad (4)$$

The unknown parameter “A” can be obtained by solving the equation for MPP(V_m and I_m)

$$\frac{I_m}{I_{sc}} = e^{\frac{qV_m}{N_s K T_o A}} - \left(\frac{I_{sc} - I_m}{I_{sc}} \right) e^{\frac{qV_{oc}}{N_s K T_o A}} \quad (5)$$

From the above equation the PV Array can be modeled as a Ideal Single Diode Model (ISDM)

B. Improved Two-Diode Model

This model consist of a PV current source, two ideal diode in parallel, series resistance R_s and shunt resistance R_{sh} [8]. The equivalent circuit is as shown in Fig.2.

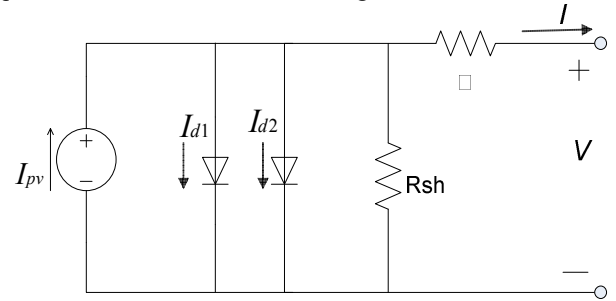

Fig. 2 Improved Two Diode Model

Equation (1) describes the output current of the cell:

$$I = I_{pv} - I_{d1} - I_{d2} - \left(\frac{V + IR_s}{R_{sh}} \right) \quad (6)$$

Where

$$I_{d1} = I_{01} \left[\exp\left(\frac{V + IR_s}{a_1 V_{T1}}\right) - 1 \right] \quad (7)$$

and

$$I_{d2} = I_{02} \left[\exp\left(\frac{V + IR_s}{a_2 V_{T2}}\right) - 1 \right] \quad (8)$$

Where I₀₁ and I₀₂ are the reverse saturation currents of diode 1 and diode 2, V_{T1} and V_{T2} are the thermal voltages of respective diodes a₁ and a₂ represent the diode ideality constants of diode 1 and diode 2. I₀₂ Term in (8), compensate the recombination loss in the depletion region as described in [5].

The Power obtained from PV Array can be obtained by multiplying Voltage (V) with Current (I, Eq(6)).

To simplify, a_1 and a_2 are assumed to be equal to 1 and 2 respectively. The values are approximation of the Shockley Read-Hall recombination in the space charge layer in photodiode.

The equation for PV current as a function of temperature and irradiance can be written as:

$$I_{pv} = (I_{pv-STC} + K_I \Delta T) \frac{G}{G_{STC}} \quad (9)$$

For simplicity I_{01} is assumed to be equal to I_{02} , the simplified equation for saturation current are as follow

$$I_{01} = I_{02} = \frac{(I_{sc-STC} + K_I \Delta T)}{\exp[(V_{oc} + K_V \Delta T)/V_T] - 1} \quad (10)$$

$$R_p = \frac{V_{mp}(V_{mp} + I_m R_s)}{[V_{mp}\{I_{pv} - I_{d1} - I_{d2}\} - P_{max,E}]} \quad (11)$$

The values of R_p and R_s are obtained through iteration this is done by maximum power (P_{mp}) matching algorithm; i.e. by iteratively increasing the value of R_s and simultaneously calculating R_p from equation (11) till calculated peak power and experimental maximum power (P_{mp}) matches.

C. Simplified Two-Diode Model

The simplified two diode model has a photo current source in parallel with two ideal diodes without series and shunt resistances as shown in Fig. 3 [9]. As a result, it leads to lesser computational time for simulation and also it needs only four parameters estimation from data sheet in order to simulate this model. Significant reduction in simulation time proves to be an advantageous while studying the mathematical modeling of PV module during STC and non-STC conditions. The detailed mathematical modeling is given as follows.

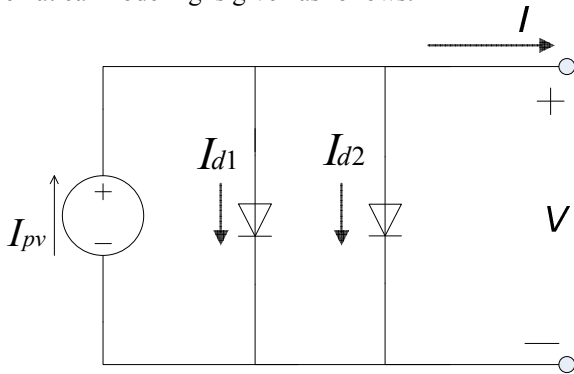

Fig. 3 Simplified two-diode model of PV module

With reference to Fig. 3, I-V characteristic of the proposed model can be expressed as follows:

$$I = I_{pv} - I_{01} \left[\exp\left(\frac{q(V)}{N_s K T A_1}\right) - 1 \right] - I_{02} \left[\exp\left(\frac{q(V)}{N_s K T A_2}\right) - 1 \right] \quad (12)$$

Here, unknown parameter to be found are I_{pv} , I_{01} , I_{02} , A_1 and A_2 respectively. I_{02} can be found in terms of I_{01} . So the remaining four unknown parameters namely; I_{pv} , I_{01} , A_1 and A_2 are to be estimated. They all are determined based on the manufacturer datasheet as explained below.

The PV current (I_{pv}) can be expressed in terms of short circuit current (I_{sc}) at STC as equation (13), taking variation of temperature and irradiation into consideration. I_{pv} has a linear relationship with irradiation (G) and short circuit current (I_{sc}) [10] and it can be given as follows:

$$I_{pv} = (I_{sc} + K_I \Delta T) G \quad (13)$$

Where I_{sc} (in Amps) is short circuit current at STC, ΔT is the temperature difference between module temperature (T) and the STC temperature, K_I is short circuit current coefficient provided in datasheet. G is the surface irradiation in kW/m^2 .

A simple equation to describe saturation current is given by

$$I_{01} = \frac{(I_{sc} + K_I \Delta T)}{\exp[(V_{oc} + K_V \Delta T) * q / (N_s K T A_1)] - 1} \quad (14)$$

In general it is found that magnitude of I_{02} is three to four times larger than I_{01} [6] and it can be expressed in terms of temperature of PV module [9] as

$$I_{02} = \left(\frac{T}{3.77}\right)^2 I_{01} \quad (15)$$

D. Finding values of A_1 and A_2

To estimate A_1 and A_2 , a simple and fast iterative method is used here. For that, the following two conditions are considered;

- At Open Circuit condition with V_{oc}
- At Maximum point power condition with V_m and I_m

During open circuit condition $V=V_{oc}$ and current is nearly zero (i.e. $I=I_{oc}=0$; $V=V_{oc}$). On simplification of equation (12) at open circuit condition, A_2 can be expressed in terms of A_1 and it is revealed in (13).

Therefore

$$0 = \left[I_{pv} - I_{01} \left[\exp\left(\frac{q(V_{oc})}{N_s K T A_1}\right) - 1 \right] - I_{02} \left[\exp\left(\frac{q(V_{oc})}{N_s K T A_2}\right) - 1 \right] \right] \quad (16)$$

$$A_2 = \frac{(qV_{oc})}{N_s T K \ln\left(\frac{I_{pv} - I_{01} (\exp(qV/(N_s K A_1 T)) - 1)}{I_{02}} + 1\right)} \quad (17)$$

The estimation of ideality constants A_1 & A_2 based on iterative matching algorithm as proposed in [7].

III. MPPT TECHNIQUES

A. Incremental Conductance (IC) Method

By measuring and comparing the incremental conductance and instantaneous conductance of PV module, the variation of the terminal voltage for PV module can be determined. If the value of incremental conductance is equal to that of instantaneous conductance, then the corresponding maximum power point is known. The advantage of the incremental conductance method is that it can calculate and find the exact perturbation direction for the operating voltage of PV modules. In theory, when the maximum power point is found by the judgment conditions ($dI/dV = -I/V$ and $dI = 0$) of the incremental conductance method, it can avoid the perturbation phenomenon near the maximum power point [8]. The Flow chart for Incremental Conductance method for determining MPP is shown in Fig.4 [8].

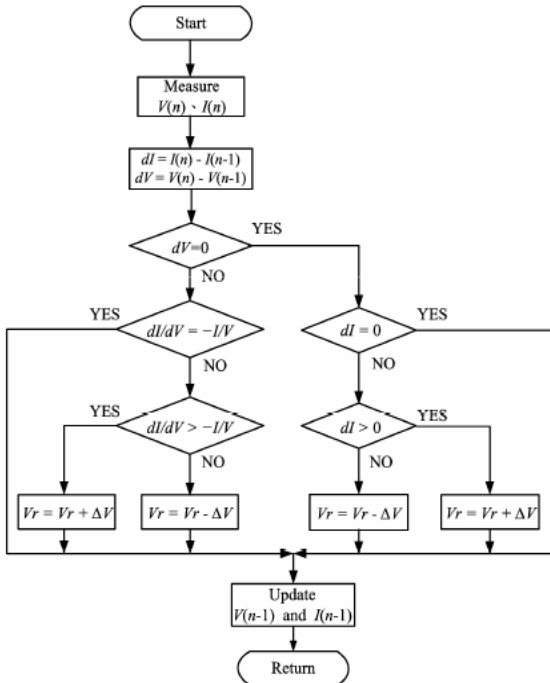

Fig. 4 The flow chart for incremental conductance method

B. Perturb & Observe (P&O) Method

By means of iteratively perturbing, observing and comparing the power generated by the PV module, maximum power point of PV module is determined. Due to its simplicity and lesser convergence for optimal MPP, this method is more popular among all methods proposed in the available literature. The basic operating procedure of P&O method is shown in Fig. 5 as flowchart. The advantages of the P&O method are simple structure, easy implementation and less required parameters.

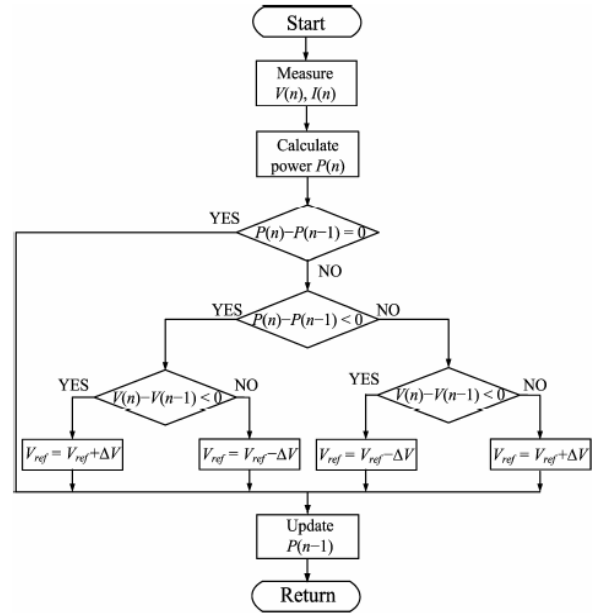

Fig. 5 The flow diagram of P&O method

IV. SIMULATION AND RESULTS

This section discusses the comparative analysis of two MPPT Algorithm on different models of PV module, The proposed study is mathematically analyzed and simulated in MATLAB/Simulink environment. The PV module considered for the comparison is Kyocera KC200GT [10] and the specifications of the KC200GT PV module are summarized in Table-I.

TABLE-I:
PV MODULE SPECIFICATIONS

Parameter	KC200GT at STC
Maximum Power(Pmax)	200 W(+10%/ -5%)
Maximum Power Voltage(Vmp)	26.3 V
Maximum Power Current(Imp)	7.61 A
Open Circuit Voltage(Voc)	32.9 V
Short Circuit Current(Isc)	8.21 A
Temperature Coefficient of V_{oc} (K_V)	$-1.23 \times 10^{-1} V/^{\circ}C$
Temperature coefficient of I_{sc} (K_I)	$3.18 \times 10^{-3} A/^{\circ}C$
Number of cell per module(N_s)	54

To compare the performance of the two MPPT Algorithm (IC and P&O) with the common fixed step size (0.1), the simulation is configured under standard test conditions (STC) to compare the performances. The irradiation was suddenly changed from 1000 to 200 W/m^2 at 0.4s and changed back to 1000 W/m^2 at 0.8s. A clear comparison can be made between IC and P&O MPPT algorithm for Ideal Single Diode PV Model

from Fig. 6. It can be clearly seen that P&O MPPT gives more ripple in the reference Voltage as compared to IC MPPT for the same step size and same conditions. The Voltage ripple comparison can be made from Fig. 7. It should be noted that Maximum Power Voltage or Reference Voltage given by ISDM PV model by IC and P&O MPPT are 26.6 V and 26.7 V respectively.

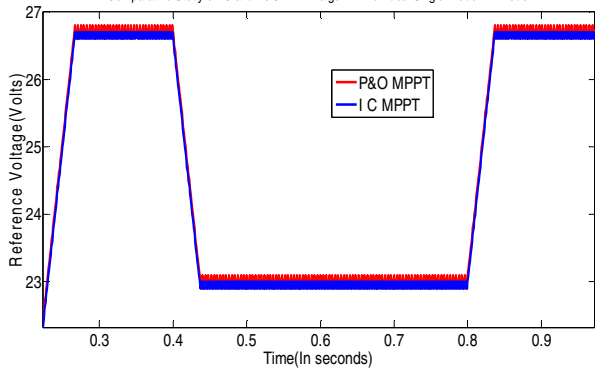

Fig.6 Comparison between IC and P&O MPPT for ISDM Model

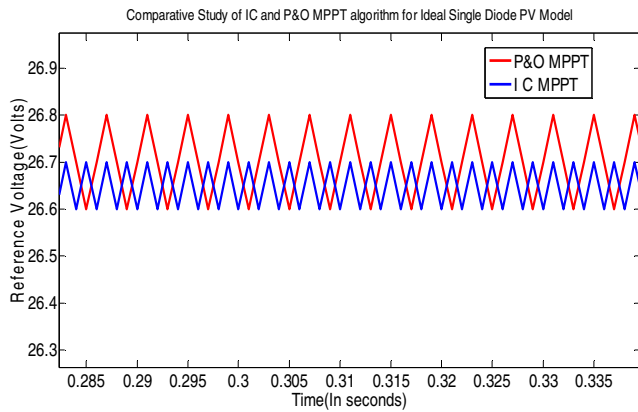

Fig.7 Comparison between Ripple voltage

Fig 8. Shows comparative study of IC and P&O MPPT Algorithm for Improved Two Diode Model .Here also P&O MPPT's Refernce Voltage is more as compared to IC MPPT for the same step size and same conditions. The Voltage ripple comparison can be made from Fig. 9. It should be noted that Maximum Power Voltage or Reference Voltage given by Improved Two Diode Model by IC and P&O MPPT are 23.3V and 26.4V respectively.

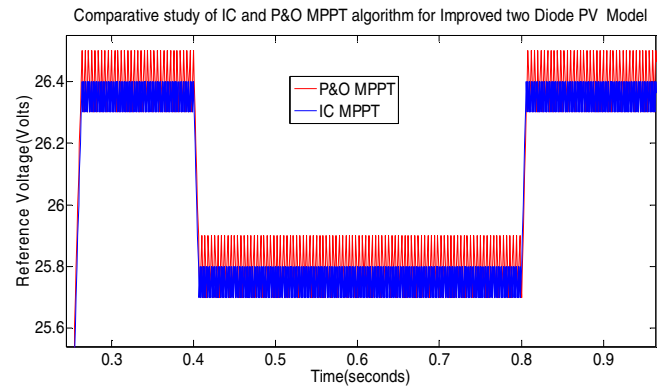

Fig.8 Comparison between IC and P&O MPPT for Improved Two Diode PV Model

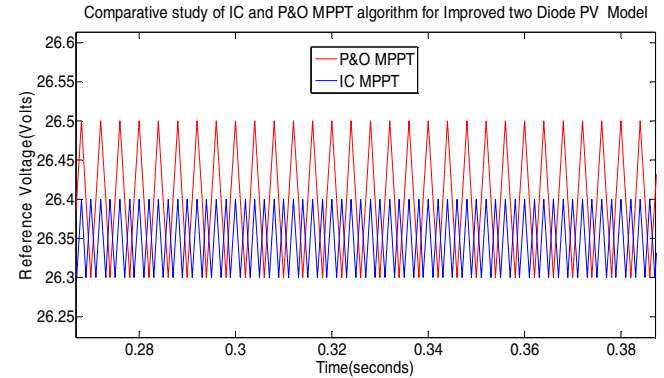

Fig.9 Comparison between Ripple Current

A. Comparative Analysis

The I-V characteristics of three modules with respect to different PV Models STC conditions are illustrated in Fig.10. It is seen that The I-V output curve for improved two diode model [5] doesn't guarantee accurate shape between the maximum power point and the open-circuit voltage. It even exhibits serious deficiencies when subjected to temperature variations. Hence the graphs deviates completely from the experimental results obtained. For ideal single diode model [6] the model is significantly improved and is almost approximated to the actual PV module but, this approach deteriorates accuracy at low irradiance, especially in the vicinity of V_{oc} . The simplified two-diode model takes advantage of the simplicity of single diode model and enhances the accuracy by deriving a mathematical representation, capable of extracting accurate estimates of the model parameters, directly related to manufacturer datasheets. The characteristics curves closely coincide with the experimental data sheet of PV module. As a result, simplified two-diode model [7] takes lesser simulation time as compared to improved two-diode model [5] and it was clearly shown in Fig.11.

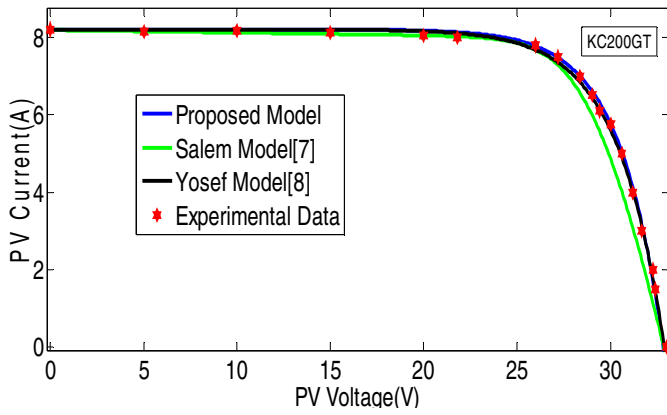

Fig.10. Comparison of I-V characteristics of KC200GT PV module between three models

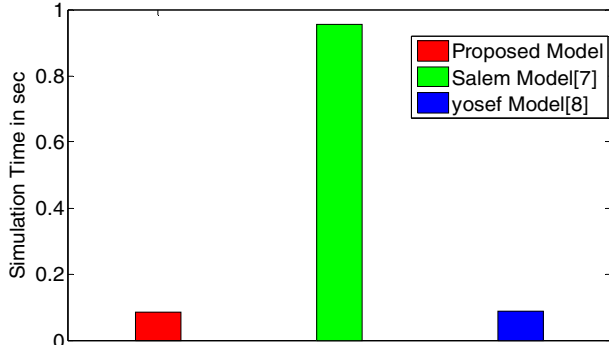

Fig.11 Simulation time of three models

V. CONCLUSIONS

The paper presents the mathematical modeling of PV module with the effective comparison of two popular MPPT Techniques. Thus it can be concluded from the study that, Incremental Conductance MPPT algorithm is better one as it has less Voltage ripple. Though P&O MPPT is much easier and easy to implement but IC MPPT algorithm gives better result. Among the PV array models, simplified two-diode model and Ideal Single Diode Model (ISDM) are simple and easy to simulate. In ISDM PV Model there is no need for any numerical solver as current is function of only the Voltage term. Therefore the simulation time for ISDM Model with MPPT algorithm is less as compared to Improved two Diode Model. Thus it is concluded that Incremental Conductance MPPT algorithm with Ideal Single Diode PV model is fast and gives desired output with less ripple voltage.

ACKNOWLEDGEMENTS

This article has been elaborated in the framework of the project New creative teams in priorities of scientific research , reg. no. CZ.1.07/2.3.00/30.0055, supported by Operational Programme Education for Competitiveness and co-financed by the European Social Fund and the state budget of the Czech Republic.

This work was partially supported by the NCN grant No. DEC-2011/01/B/ST8/02515 (Poland).

REFERENCES

- [1] Mukund R. Patel, "Wind and Solar Power Systems: Design, Analysis, and Operation", CRC Press, second edition, July 2005.
- [2] Kftichios Koutroulis, Kostas Kalaitzakis et al."Development of a Microcontroller-Based, Photovoltaic Maximum Power Point Traking Control System" *IEEE Trans on Power Electronics*, Vol 16, No. 1, Pp.46-54, Jan 2001.
- [3] Yuncong Jiang; Qahouq, J.A.A.; Haskew, T.A., "Adaptive Step Size With Adaptive-Perturbation-Frequency Digital MPPT Controller for a Single-Sensor Photovoltaic Solar System," *Power Electronics, IEEE Transactions on* , Vol.28, No.7, Pp.3195-3205, July 2013
- [4] X. Zhou , D. Song , Y. Ma and D. Cheng "The simulation and design for MPPT of PV system based on incremental conductance method", Proc. Information Engineering (ICIE), 2010 WASE International Conference on vol. 2, Pp.314 -317, 2010.
- [5] G.R.Walker, "Evaluating MPPT converter topologies using a Matlab PV model," *Journal of Elect.Electron. Eng.*, vol. 21, pp 49-55, 2001, Australia.
- [6] M. G. Villalva, J. R. Gazoli, and E. R. Filho, "Comprehensive approach to modeling and simulating photovoltaic arrays," *IEEE Trans. Power Electron.*, Vol. 24, No. 5, Pp. 1198–1208, May 2009.
- [7] Yousef Mahmoud et al., "A Simple Approach to Modelling and Simulation of Photovoltaic Modules," *IEEE Trans. on Sustainable Energy*, Vol. 3, No. 1 ,pp.185-186, Jan 2012
- [8] Z.Salam et al., "An improved two-diode photovoltaic(PV) model for PV system," in Proc. Joint Int. Conf. Power Electron., Drives and Energy Syst., India, pp.1-5, Dec 2010.
- [9] B.Chitti Babu, Gurjar, S., "A Novel Simplified Two-Diode Model of Photovoltaic (PV) Module," *Photovoltaics, IEEE Journal of* , Vol.4, No.4, Pp.1156-1161, July 2014
- [10] KC200GT High Efficiency Multicrystal Photovoltaic Module Datasheet Kyocera.[online].Available: <http://www.kyocera.com.sg/products/solar/pdf/kc200gt.pdf>